

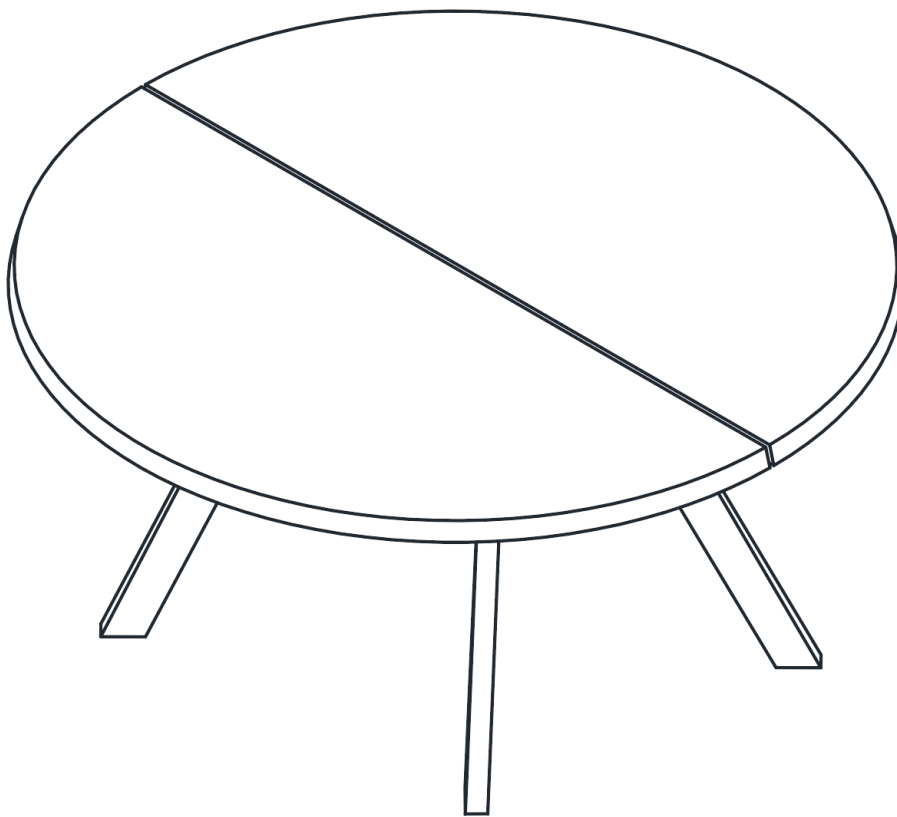

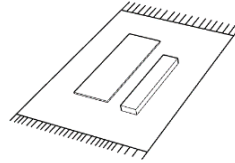

ROWICO.

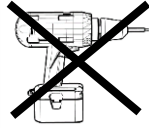

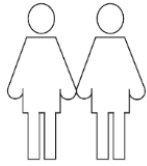

Fred round table 160



ROWICO.

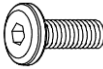

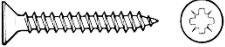
| List of part | | |
|--------------|---|------------|
| | Description | N.o of pcs |
| A | Table tops halves  | 2 |
| B | Wooden reinforcement sticks  | 2 |
| C | Metal legs  | 2 |

| List of hardware | | |
|------------------|--|-----------|
| a |  M8x20 | 16 |
| b |  Ø22/ Ø8 | 16 |
| c |  4,5X40 PZ2 | 16 |
| d |  Wooden 10mm distance | 2 |
| e |  H5 | 1 |

Attention:

Var noga med att skydda bordskivans topyta innan ni vänder bordet upp och ner.

Make sure that you protect the table top surface before you turn it around on the floor.

ROWICO.

Step 1

Lägg bordshalvorna upp och ner. Lägg trädistanserna mellan halvorna för att få rätt mellanrum/distans. Montera förstärkningsreglarna med de bifogade träskruvarna.

Put the table tops halves with the top side downwards. Put the wooden distance between the table top halves to get the correct gap. Assemble the wooden reinforcement stickers with the wooden screws in the predrilled holes.

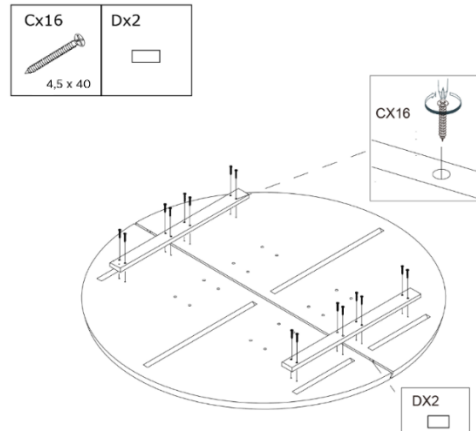

Step 2

Assemble the metal legs with the attached screws and washers and turn around the table

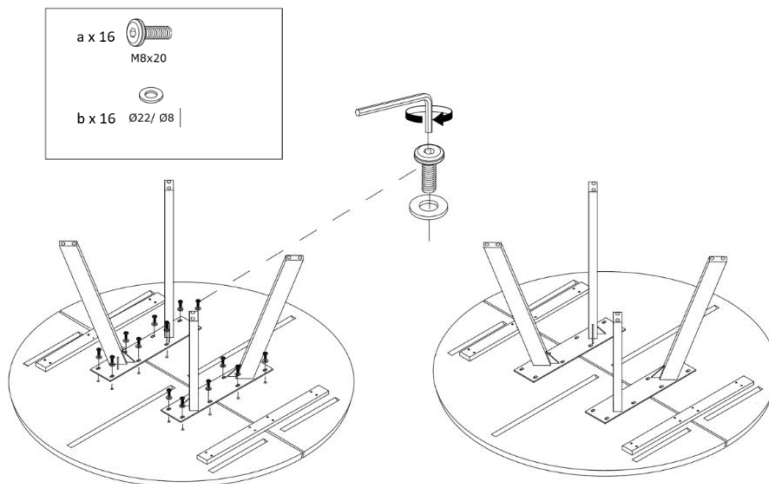

For more information visit: WWW.ROWICO.COM