

Assembling instruction

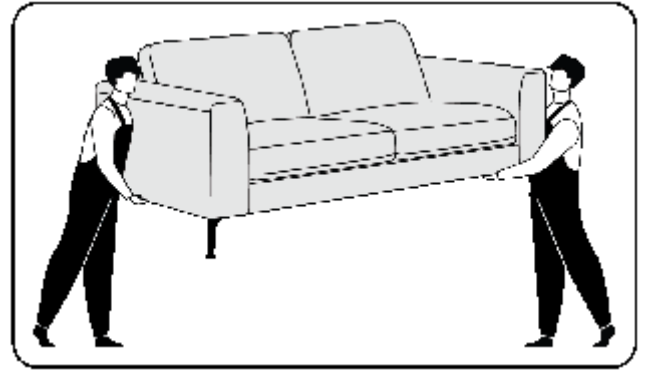

A
A1
A2

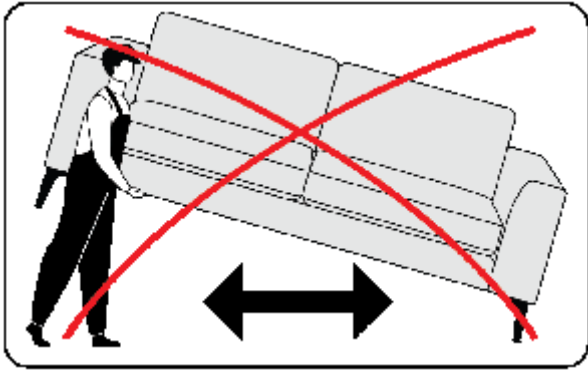

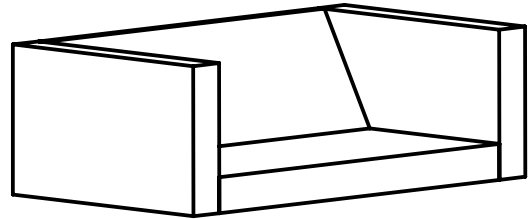
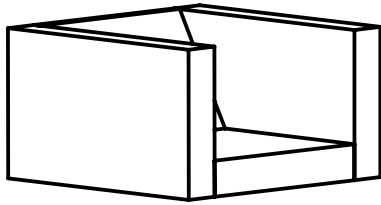

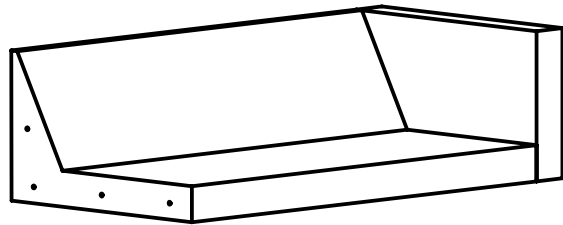
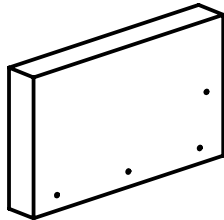



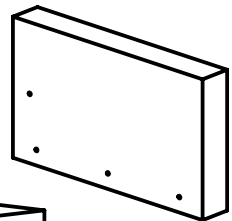
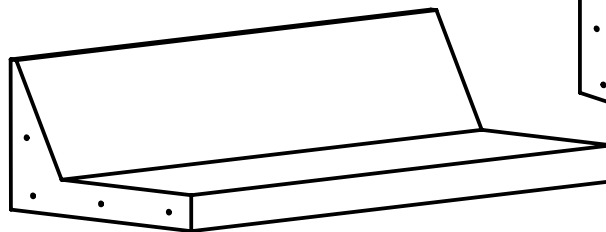
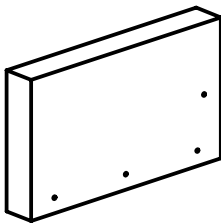

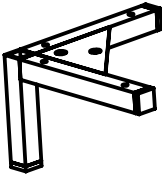



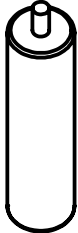

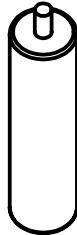

B
E
E1
E2

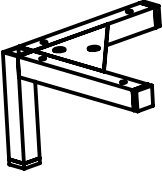









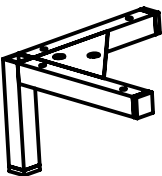







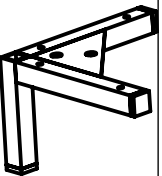

C
D











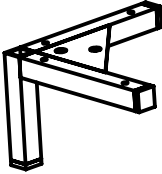

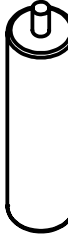

					A1		A2	
A	a x 4	b x 4	c x 16	h x 1	a2 x 1	j x 1	a2 x 2	j x 2
		 M8x20	 4x45	 5mm	 EXTRA		 EXTRA	

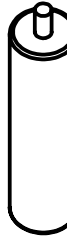
B	a x 4	b x 4	c x 16	d x 4	e x 4	f x 4	g x 1	h x 1
		 M8x20	 4x45	 M8x60	 M8	 M8	 13mm	 5mm

C	a x 4	b x 4	c x 16	d x 8	e x 8	f x 8	g x 1	h x 1
		 M8x20	 4x45	 M8x60	 M8	 M8	 13mm	 5mm

D	a1 x 4	a2 x 1	b x 4	c x 16	d x 8	e x 8	f x 8	g x 1
		 EXTRA	 M8x20	 4x45	 M8x60	 M8	 M8	
	h x 1	j x 1						
	 5mm							

E		 M8x20	 c x 16 4x45	 h x 1 5mm	A1		A2	
					 a2 x 1 EXTRA	 j x 1	 a2 x 2 EXTRA	 j x 2
					 d x 4 M8x60	 e x 4 M8	 f x 4 M8	 g x 1

I

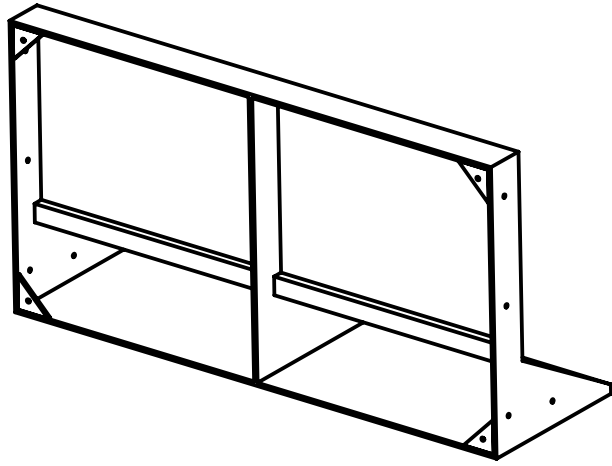

II

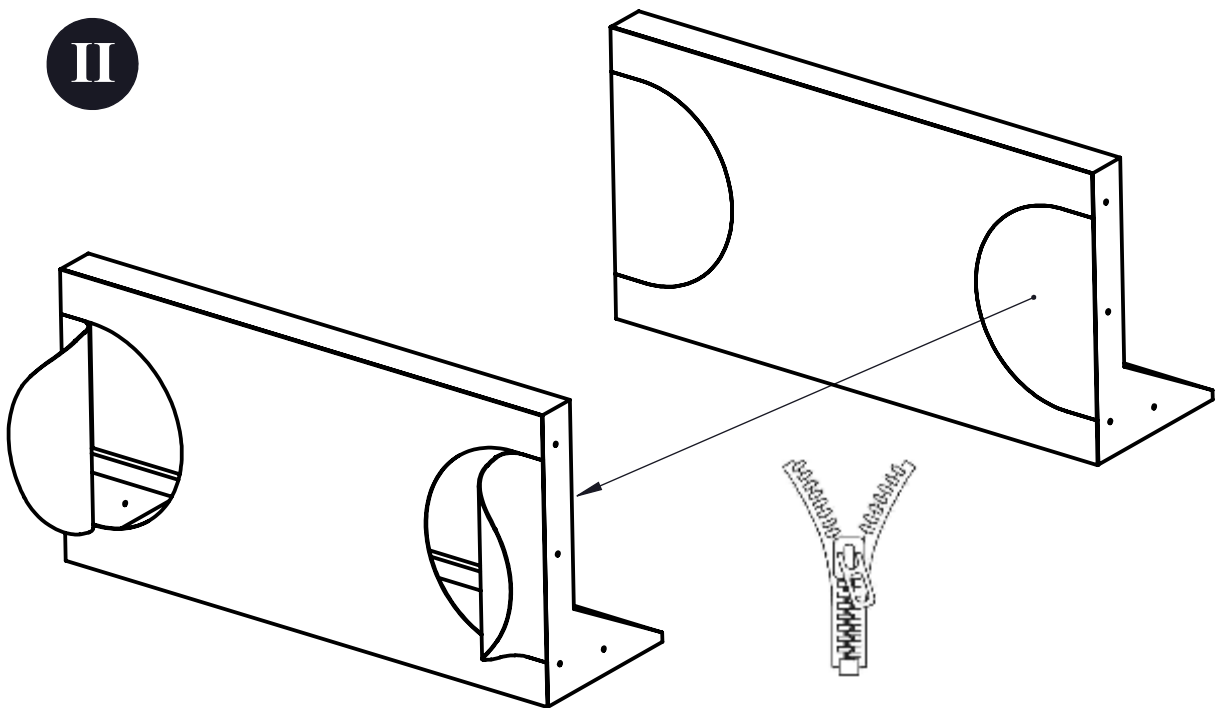

A/A1

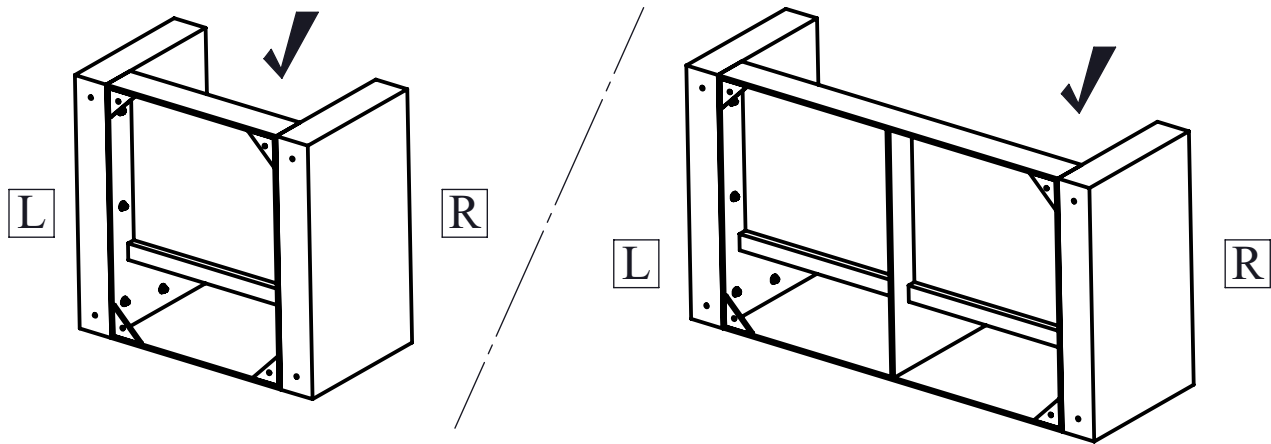

B E E1 E2

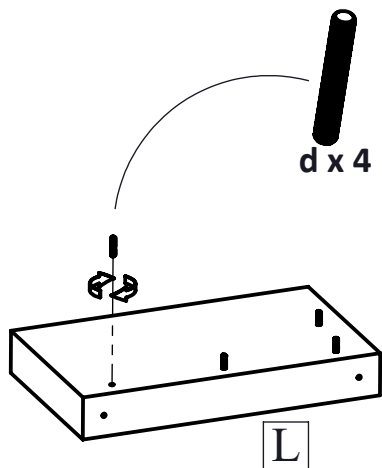

C D

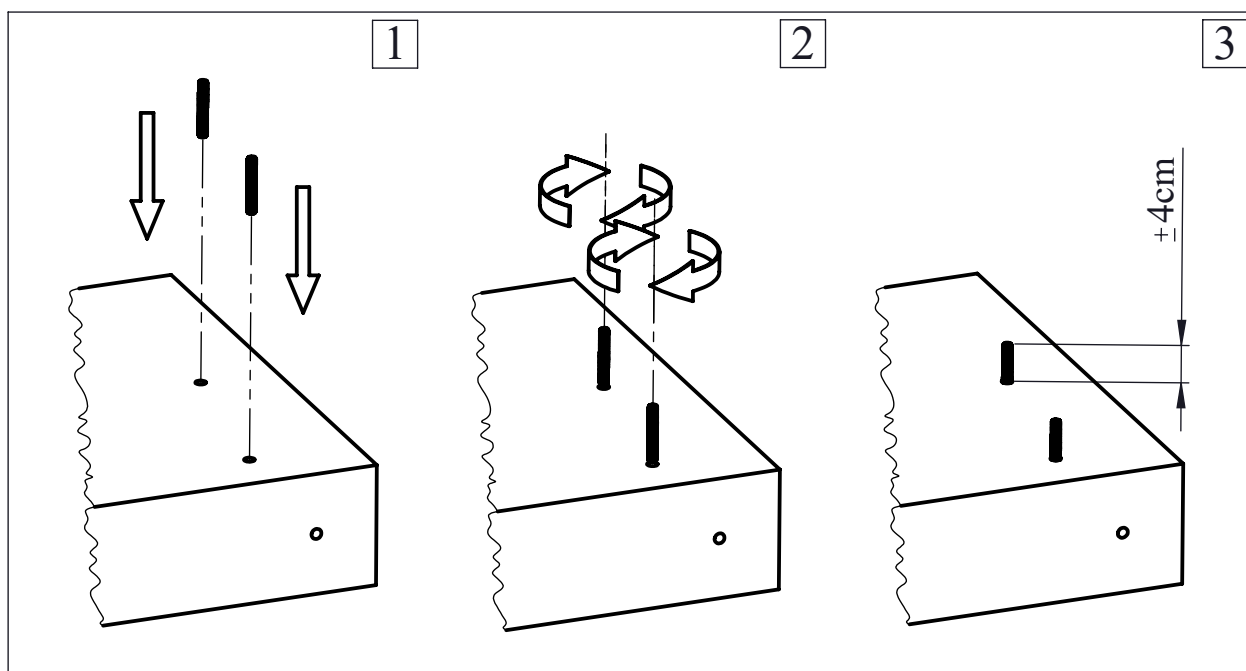
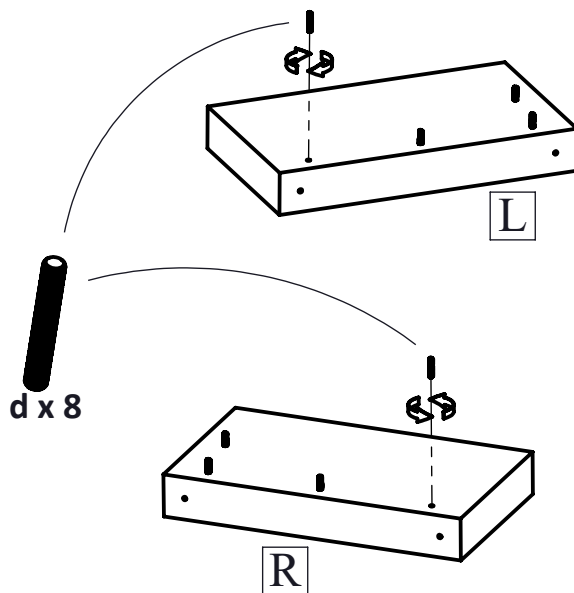

B
E
E1
E2

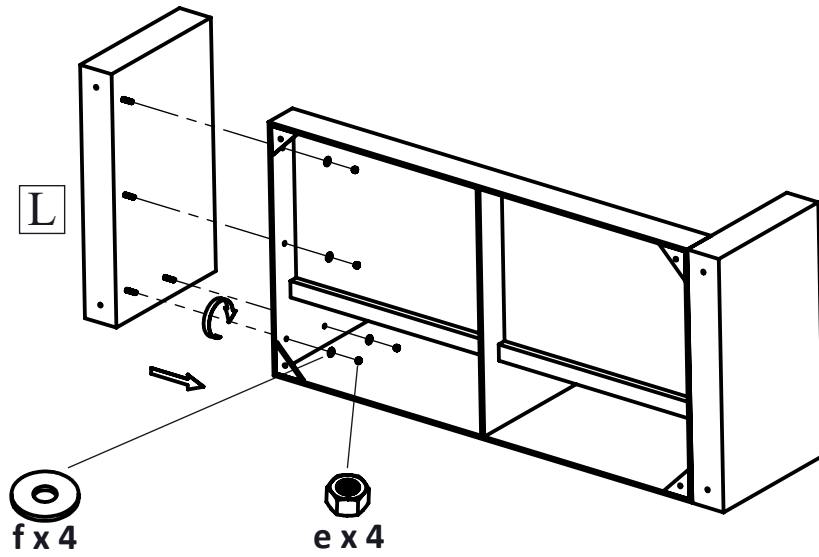

C
D

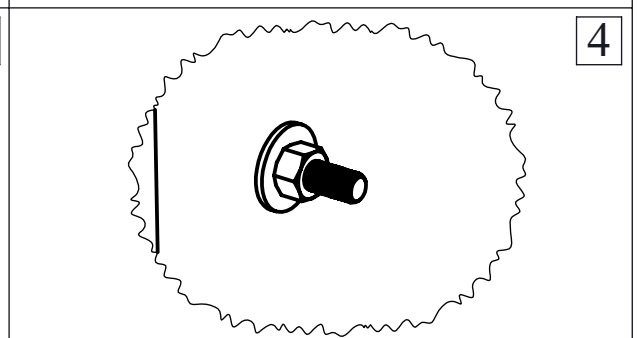
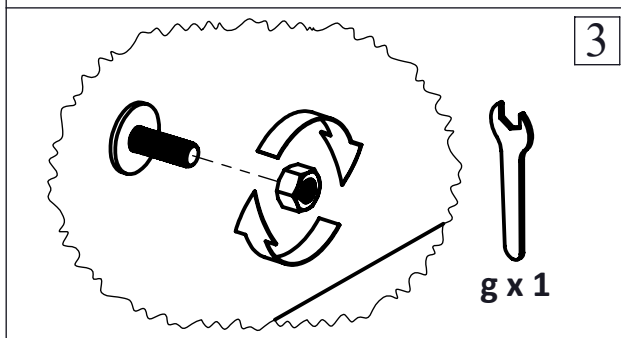
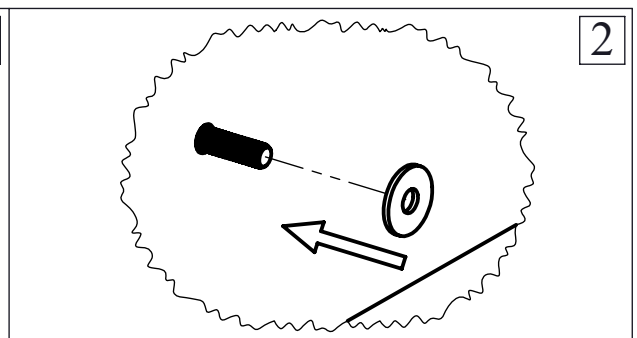
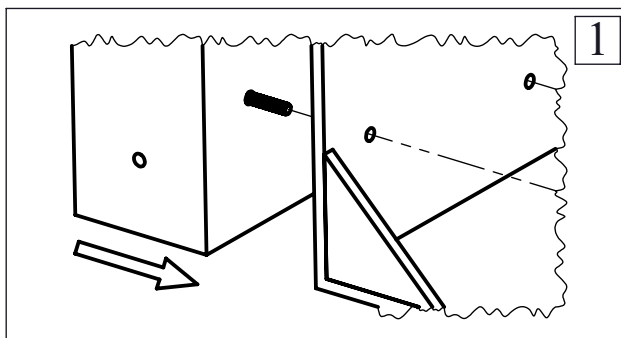
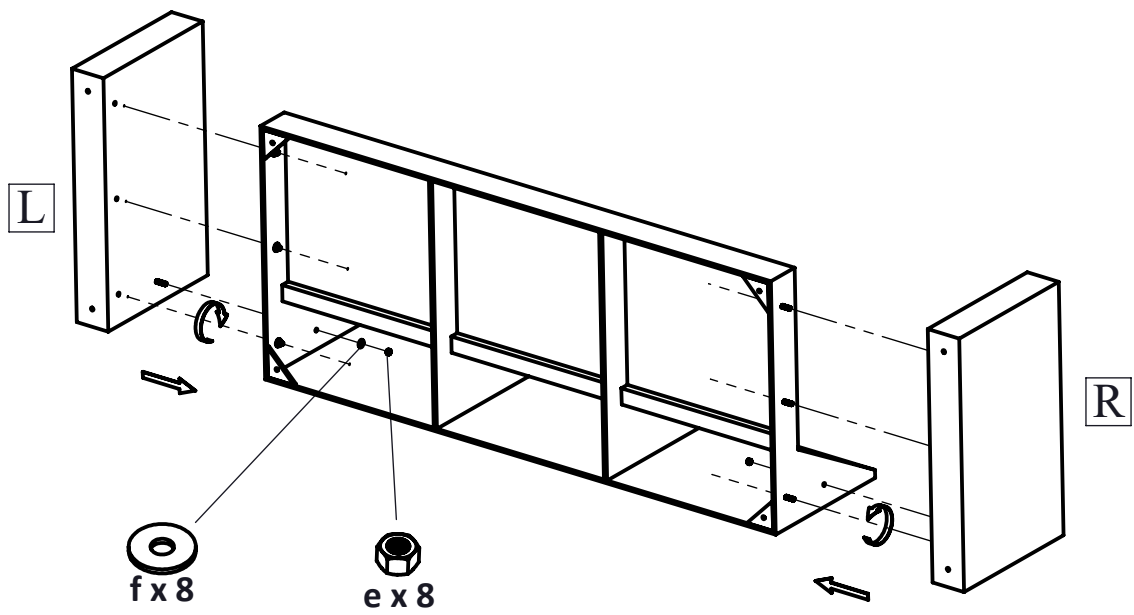

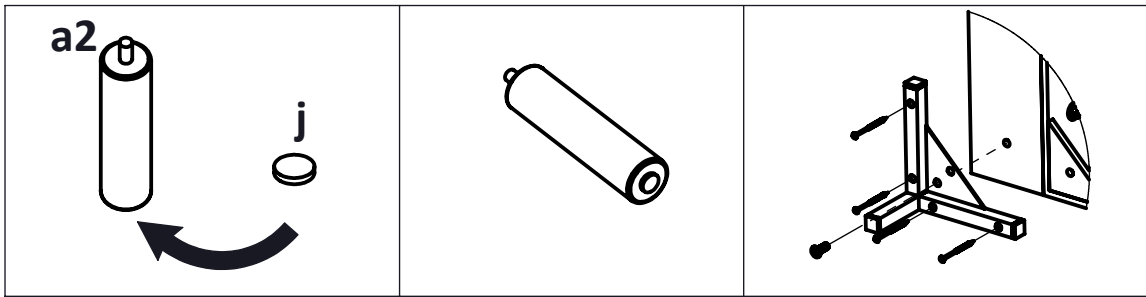

A
B
C
E

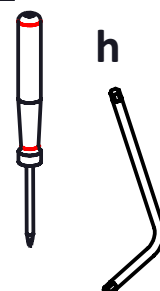
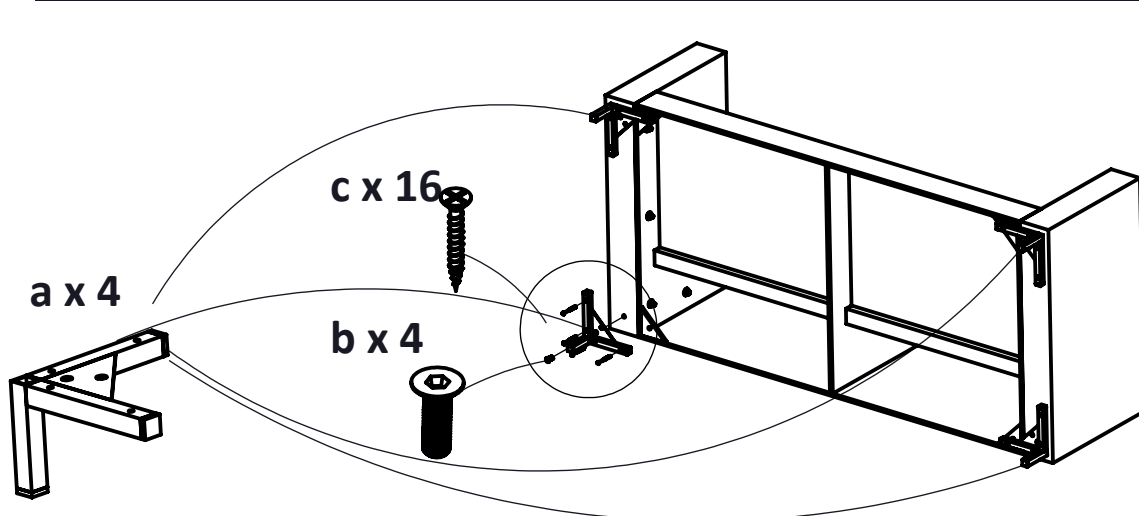

A2
E2

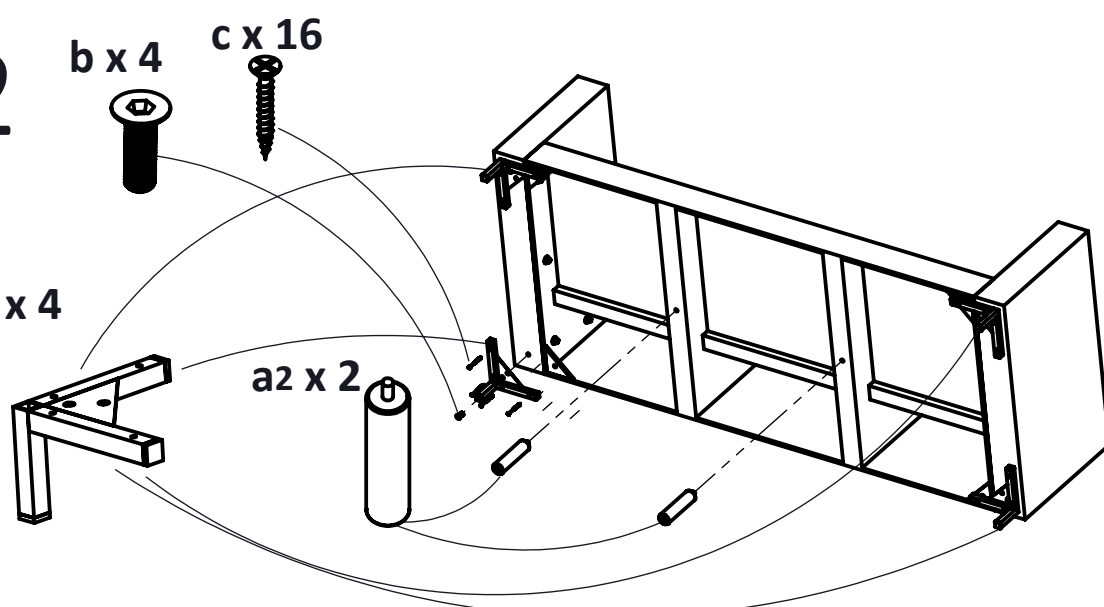

A1
E1
D

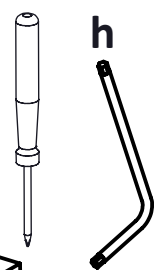
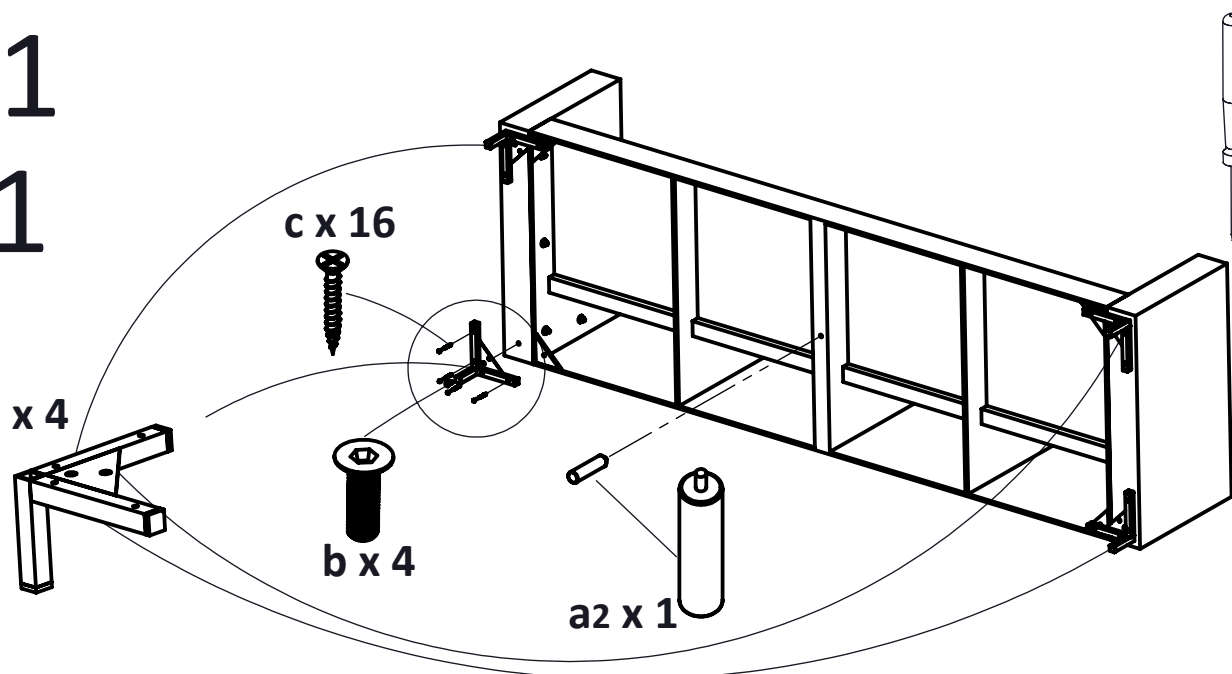

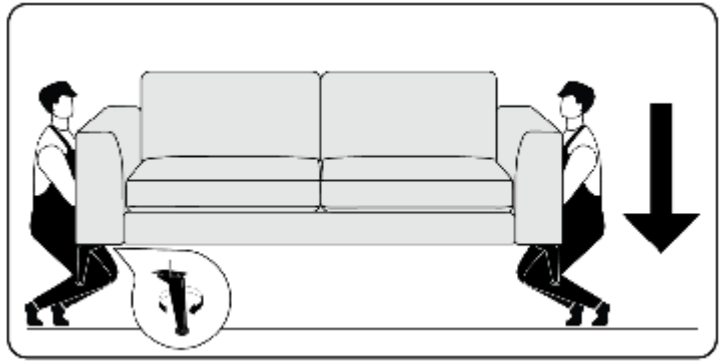
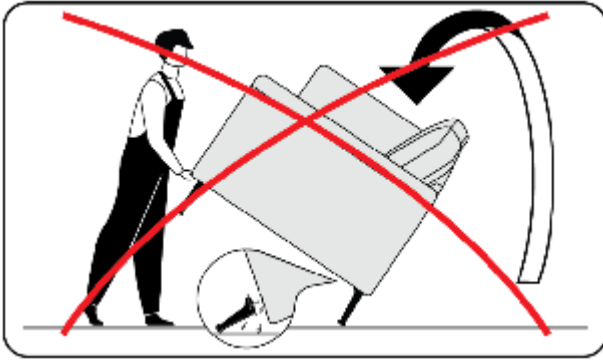

V1

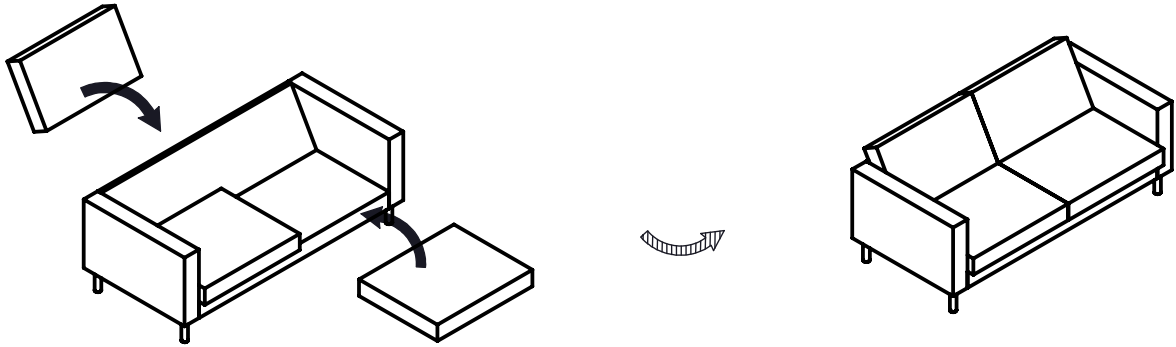

V2

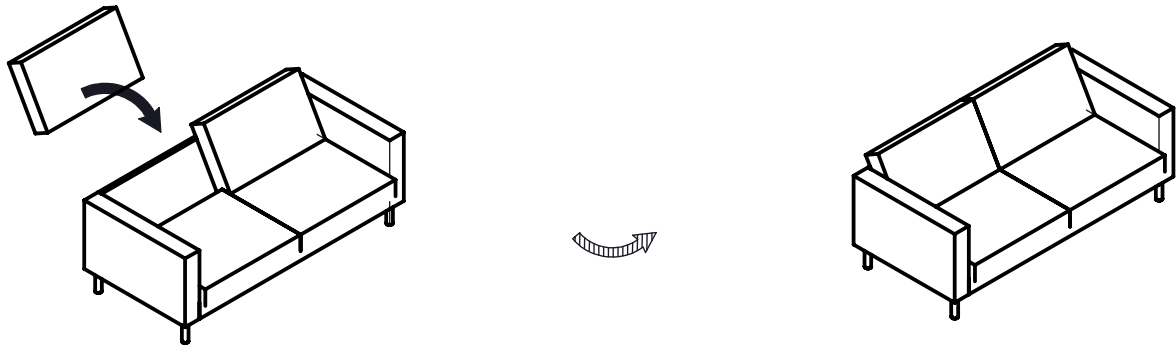

V3

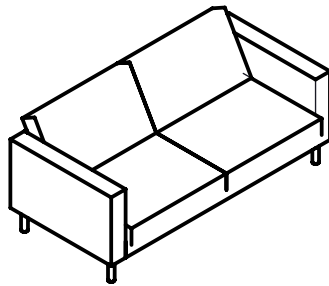

V4

